

User's Manual

CNPS11X Performa+

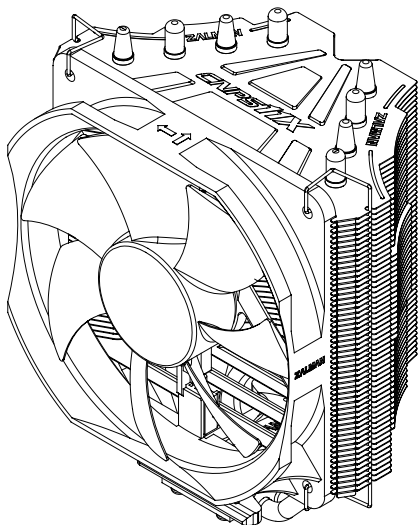

Intel Socket LGA 2011 V3/2011/1366/115X/775 CPUs
AMD Socket FM2/FM1/AM3+/AM3/AM2+/AM2 CPU & APUs

To ensure safe and easy installation,
Please read the following precautions.

www.ZALMAN.com

1 Precautions

- This cooler must be used with a 120mm fan.
- Avoid inserting objects or hands into the fan while it is in operation to prevent product damage and injuries.
- Do not ingest the Thermal Grease, and avoid its contact with skin and eyes. If contact is made with skin, wash off with water. If ingested or irritation persists, seek medical attention.
- To prevent possible injuries, gloves must be worn while handling this product.
- Excessive force exerted on the fan may cause damage to the fan and/or system.
- Use and keep product away from reach of children.
- Check the components list and condition of the product before installation. If any problem is found, contact the retailer to obtain a replacement.
- During transportation of the system, the cooler must be removed. Zalman is not responsible for any damages that occur during the transport of a system.
- Product design and specifications may be revised to improve quality and performance.

2 Specifications

Model	CNPS11X Performa+	
Dimensions	132(L) X 94.5(W) X 153.5(H)mm	
Weight	450g	
Material	Pure Copper and Aluminum	
Heat Dissipation Area	5,310cm ²	
Fan	Dimension	Ø120 x 25(H)mm
	Speed	1,000 – 1,600RPM ±10%
	Noise Level	17 – 26dBA ±10%
	Bearing Type	Long Life Bearing
	Control Method	PWM Control, Auto Restart
Connector	4Pin	
Input Voltage	12V	
Socket	Intel Socket LGA 2011 V3/2011/1366/115X/775 CPUs AMD Socket FM2/FM1/AM3+/AM3/AM2+/AM2 CPU & APUs	
Thermal Grease	ZM-STG2M(ver2)	

3 Components

Common Components

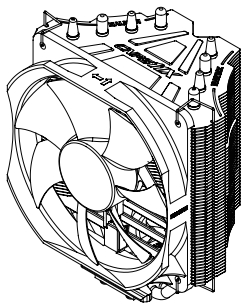

Cooler

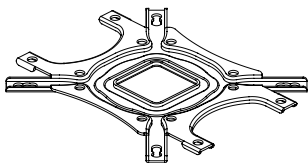

Backplate



Side Caps

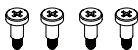

Bolts



Nuts



Manual

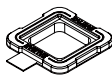

Loading Block

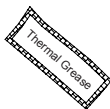

Thermal Grease
[ZM-STG2M]

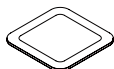

Double-sided
Tape

Intel Components

- Socket LGA 2011 V3/2011/1366/115X/775
- Stand off

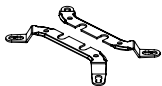

Intel Clip



Stand-off

AMD Components

- Socket FM2/FM1/AM3+/AM3/AM2+/AM2

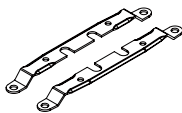

AMD Clip

4 Installation Requirements

■ Space Requirements

The cooler's installation requires an unobstructed space of 94.5mm(width) 132mm(length) and 153.5mm(height) with the CPU as a central reference point. Please check if components such as ODDs and PSU protrude into the required space.

■ Air Guide Removal

Air guides on enclosures must be removed before the cooler's installation since they protrude into the cooler's required space.

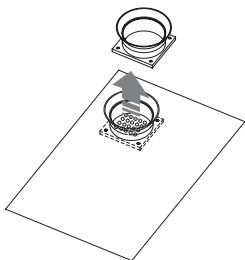
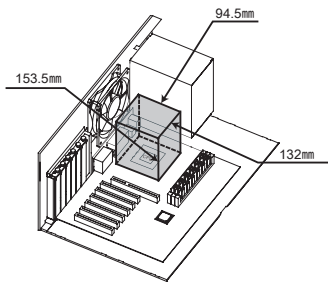

■ Cooler Orientation

As shown in the diagram below, it is recommended that the cooler be installed so that air flows from the cooler toward the enclosure's rear exhaust fan to be released.

* Recommended cooler orientation may differ according to the motherboard model.

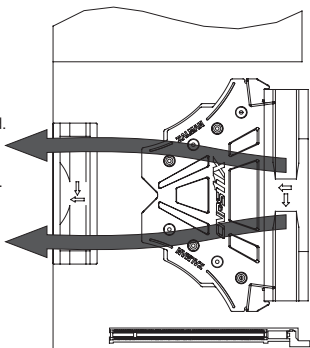

■ CPU and RAM interference check

Any RAM with a height taller than 36mm (1.42) will have interference with the CPU cooler. Please check the height of your RAM modules prior to installation.

5 Installation

LGA Intel Socket Installation

■ Intel Socket 2011 V3 / 2011 User

Partially unscrew the four bolts located on the base of the CPU cooler. Then insert the Intel Clips between the base and the heatpipe cover, with the clips bent away from the heatsink.

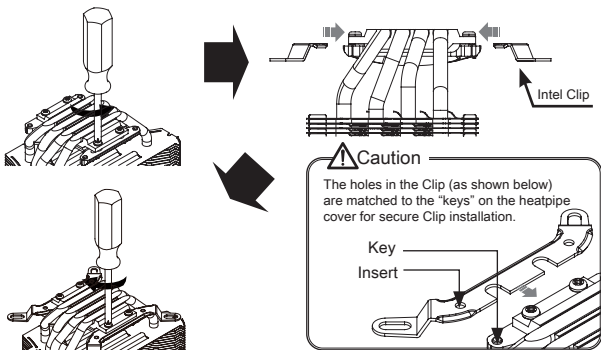

■ Intel Socket 1366 / 115X / 775 User

Partially unscrew the four bolts located on the base of the CPU cooler. Then, insert the Intel Clips between the base and the heatpipe cover, with the clips bent away from the heatsink.

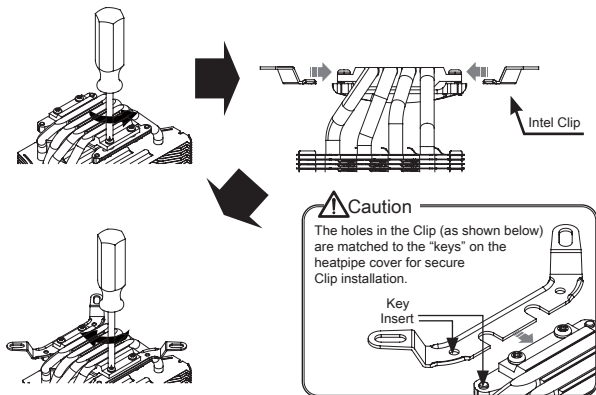

Install the Bolts to the Backplate according to the socket type and secure them with Side Caps.

※ Backplate is not needed for LGA 2011 V3 / 2011 sockets.

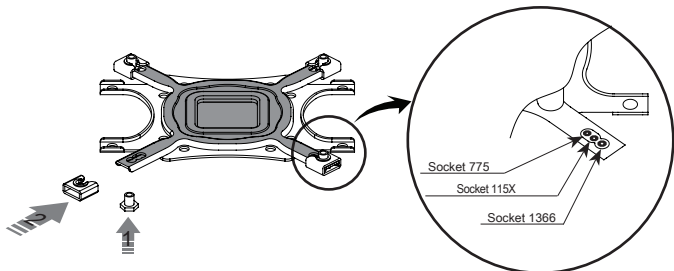

Caution

Take note of the orientation of the Nuts and the Side Caps.

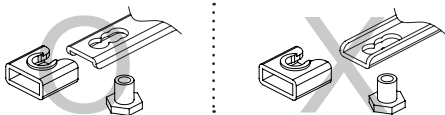

■ Socket 1366 / 115X Installation

Peel off one side of the Double-sided Tape and attach it to the center of the Backplate with the sticky side facing down. Then, peel off the top cover.

※ Socket 1366/115X Installation does not require the Loading Block.

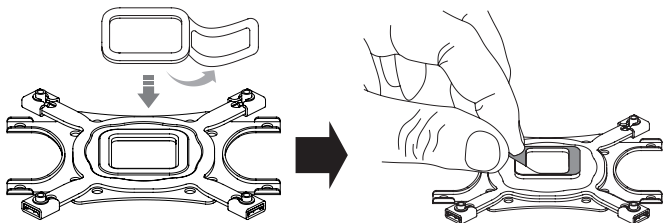

■ Socket 775 Installation

Peel off the Loading Block cover and attach it to the Backplate with the sticky side facing the center of the Backplate.

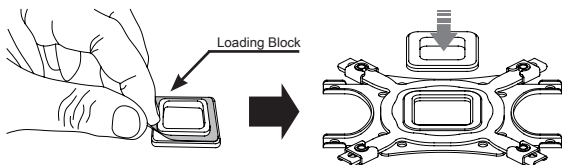

Peel off one side of the Double-sided Tape and attach it with the sticky side facing the Loading block. Then, peel off the top cover.

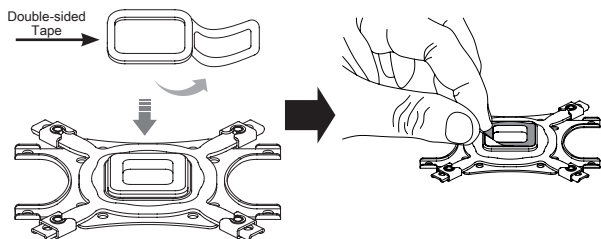

Caution

Please make note of the orientation of the Loading Block's Installation.

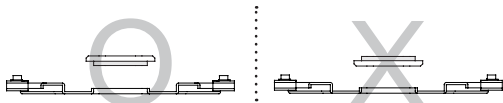

Socket 1366 / 115X / 775 User

Attach the Backplate assembly to the back side of the motherboard by aligning the Nuts to the motherboard mounting holes. If you were unsuccessful at first attempt, you may continue with the installation without the Double-sided Tape as it is not a necessary component.

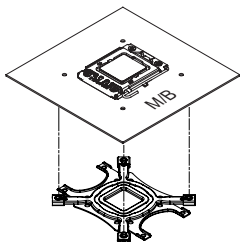

Socket 2011 V3 / 2011 User

Fasten the four Stand-offs to the motherboard. Backplate is not needed.

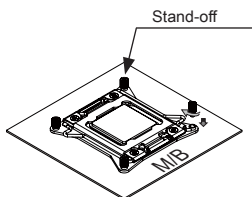

Apply thermal grease just enough to thinly cover the CPU surface, then fasten the Bolts to install the cooler.

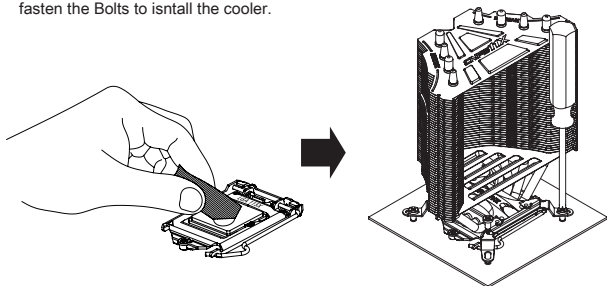

Latch the Fan Fixing Clips to the notches located on the sides of the heatsink.

Note: It is often easier to latch the Fan Fixing Clips one at a time.

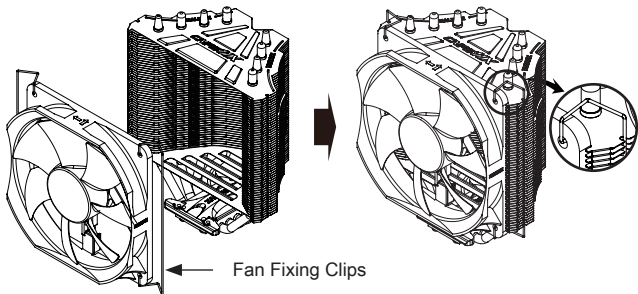

Connect the cooler's 4-pin connector to the motherboard's CPU Fan header.

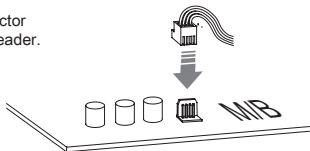

Caution

Please make sure that PWM Control Mode is activated in the motherboard's BIOS settings.

AMD Socket Installation

Partially unscrew the four bolts located on the base of the CPU cooler. Then, insert the AMD Clips between the base and the heatpipe cover, with the clips bent away from the heatsink.

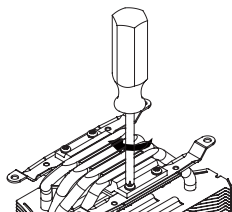
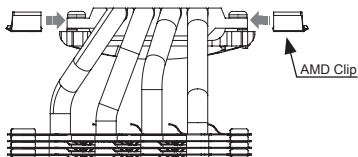
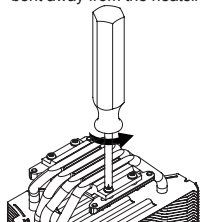

Caution

The holes in the Clip (as shown below) are matched to the "keys" on the heatpipe cover for secure Clip installation.

Key
Insert

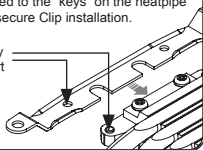

Install Bolts to the Backplate according to the Socket Type and secure with Side Caps.

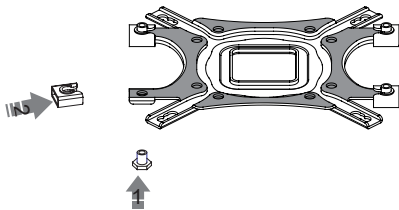

Caution

Take note of the orientation of the Nuts and the Side Caps.

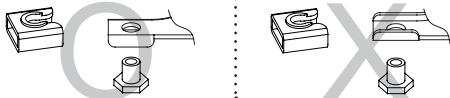

Peel off the Loading Block cover and attach it to the Backplate with the sticky side facing the center of the Backplate.

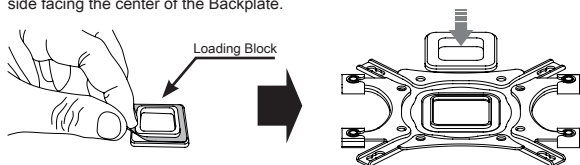

Peel off one side of the Double-sided Tape and attach it with the sticky side facing the Loading block. Then, peel off the top cover.

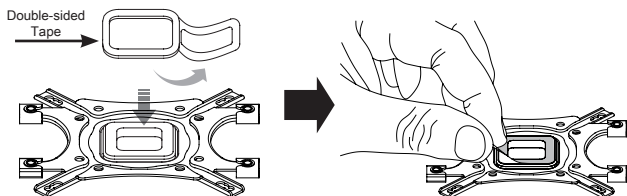

Caution

Please make note of the orientation of the Loading Block's Installation.

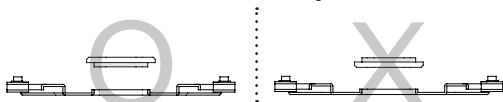

Dismantle the CPU cooler retention bracket on the motherboard by unscrewing the four bolts located at each corner (method may vary; consult the motherboard manual for details). Be sure to keep the retention bracket so the stock CPU cooler can be used as a backup.

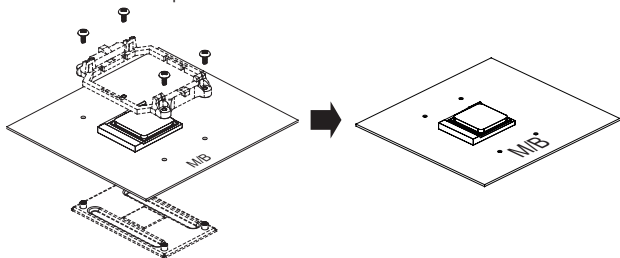

Attach the Backplate assembly to the back side of the motherboard by aligning the Nuts to the motherboard mounting holes. If you were unsuccessful at first attempt, you may continue with the installation without the Double-sided Tape as it is not a necessary component.

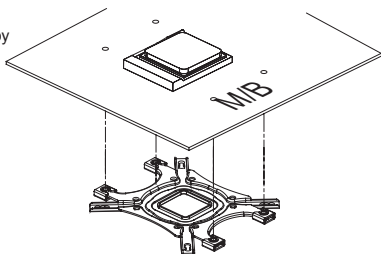

Apply thermal grease just enough to thinly cover the CPU surface, then fasten the Bolts to install the cooler.

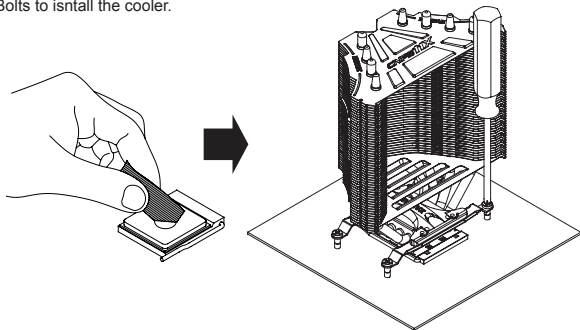

Latch the Fan Fixing Clips to the notches located on the sides of the heatsink.
Note: It is often easier to latch the Fan Fixing Clips one at a time.

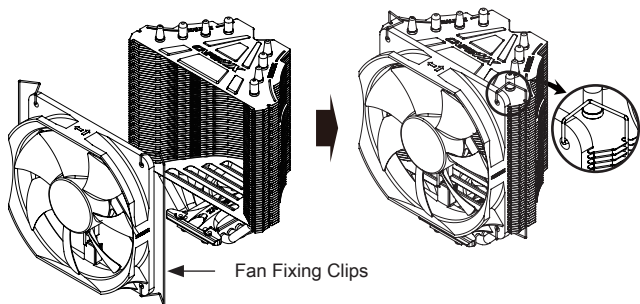

Connect the cooler's 4-pin connector to the motherboard's CPU Fan header.

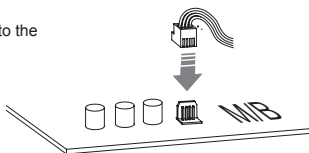

Caution

Please make sure that PWM Control Mode is activated in the motherboard's BIOS settings.